

PROJECT	_____
TYPE	_____
SPECIFIER	_____
QUANTITY	_____
DATE	_____

DO NOT DISTURB SUSPENSION

D131053-

base number Finish
Options

- To build a product code in our configurator select the specify button on the base model # product page
- To build a manual product code on this datasheet choose from the options listed below in blue font and add the suffix to the base model #

GENERAL

Series: Do Not Disturb
 Partner: Knikerboker
 Division: Design
 Installation: Suspension
 Product Type: Pendant
 Mounting Location: Ceiling
 Light Distribution: Direct / Indirect

PHYSICAL

Shape: Round
 Length (mm): 185
 Length (in): 7 5/16
 Width (mm): 25
 Width (in): 1
 Max. Overall Height (mm): 2000
 Max. Overall Height (in): 78 3/4
 Diffuser: Opal
 Fixture Finish: EWH / EBK / MAN / COF / PRD / SLF / GLF / CLF / BRL
 Fixture Material: Metal
 Cable Details: Silicon Coaxial Cable 1500mm

ELECTRICAL

Lamp Type: LED
 Input Wattage (W): 8
 Total Output Wattage (W): 7
 Dimming: 0-10V Dimming / Phase Dimming (120Vac Only)
 Driver Included: Yes
 Driver Location: Integrated
 Driver Type: Constant Voltage - 120 / 277Vac
 Driver Class: Class 2
 Input Voltage (V): 120 - 277
 Output Voltage (V): 24
 Upon Request: (Not included - see components) Remote: 0-10Vdc dimming / (Included) Integral: Phase dimming @120Vac only / Non-dimming 277Vac

LED

Number of LEDs: 1
 Color Temperature (°K): 3000
 Nominal Lumen (lm): 1000
 CRI: >85 CRI
 Lamp Life (hrs): 50000

OPTICAL

RATINGS AND CERTIFICATIONS

Certified By: Certified for North American Standards
 IP rating: IP20

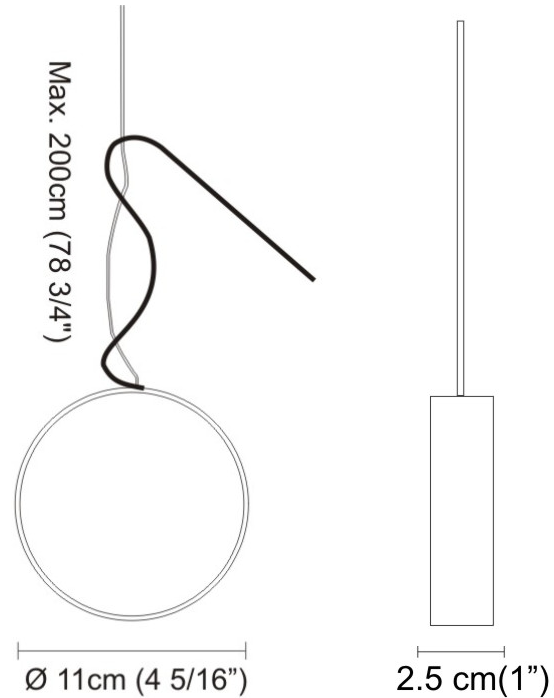

DO NOT DISTURB SUSPENSION

D131053-

PROJECT _____

TYPE _____

SPECIFIER _____

QUANTITY _____

DATE _____

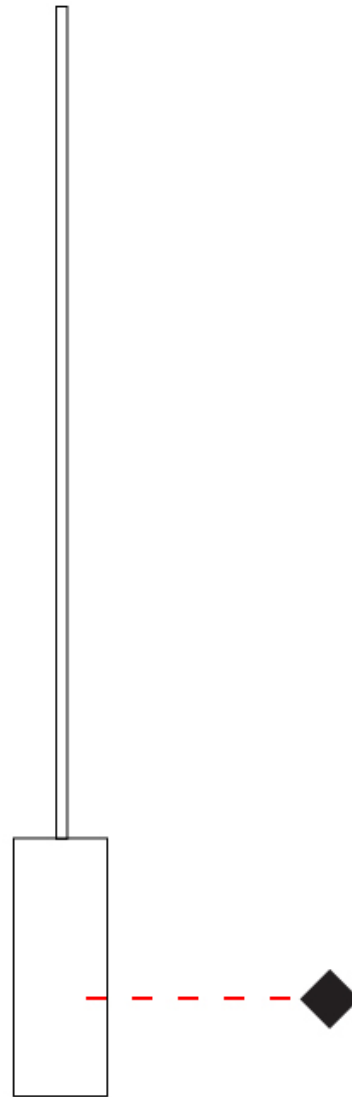
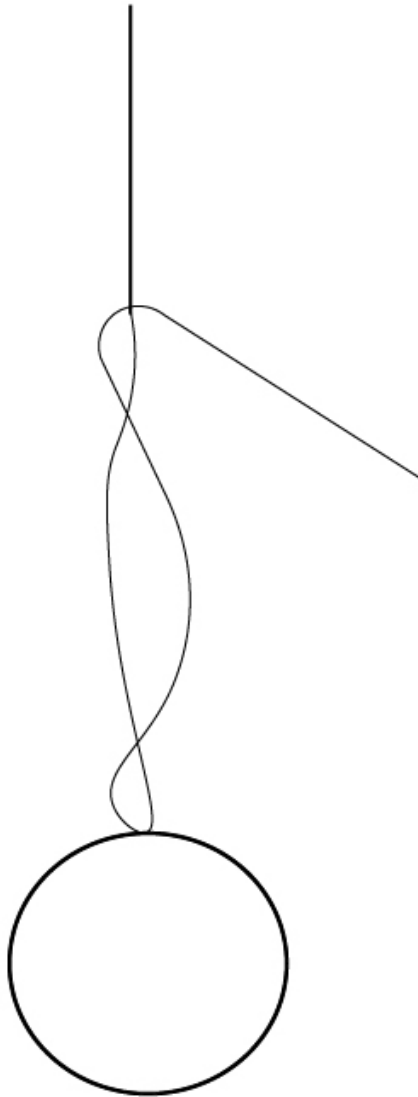

D

DO NOT DISTURB SUSPENSION

D131057-

base number _____
 Finish _____
 Options _____

- To build a product code in our configurator select the specify button on the base model # product page
- To build a manual product code on this datasheet choose from the options listed below in blue font and add the suffix to the base model #

GENERAL

Series: Do Not Disturb _____
 Partner: Knikerboker _____
 Division: Design _____
 Installation: Suspension _____
 Product Type: Pendant _____
 Mounting Location: Ceiling _____
 Light Distribution: Direct / Indirect _____

PHYSICAL

Shape: Round _____
 Length (mm): 110 _____
 Length (in): 4 ⁵/₁₆ _____
 Width (mm): 25 _____
 Width (in): 1 _____
 Max. Overall Height (mm): 2000 _____
 Max. Overall Height (in): 78 ³/₄ _____
 Diffuser: Opal _____
 Fixture Finish: EWH / EBK / MAN / COF / PRD / SLF / GLF / CLF / BRL _____
 Fixture Material: Metal _____
 Cable Details: Silicon Coaxial Cable 1500mm _____

ELECTRICAL

Lamp Type: LED _____
 Input Wattage (W): 8 _____
 Total Output Wattage (W): 7 _____
 Dimming: 0-10V Dimming / Phase Dimming (120Vac Only) _____
 Driver Included: Yes _____
 Driver Location: Integrated _____
 Driver Type: Constant Voltage - 120 / 277Vac _____
 Driver Class: Class 2 _____
 Input Voltage (V): 120 - 277 _____
 Output Voltage (V): 24 _____
 Upon Request: (Not included - see components) Remote: 0-10Vdc dimming / (Included) Integral: Phase dimming @120Vac only / Non-dimming 277Vac _____

LED

Number of LEDs: 1 _____
 Color Temperature (°K): 3000 _____
 Max. Delivered Lumen (lm): 1000 _____
 CRI: >85 CRI _____
 Lamp Life (hrs): 50000 _____

OPTICAL

RATINGS AND CERTIFICATIONS

Certified By: Certified for North American Standards _____
 IP rating: IP20 _____

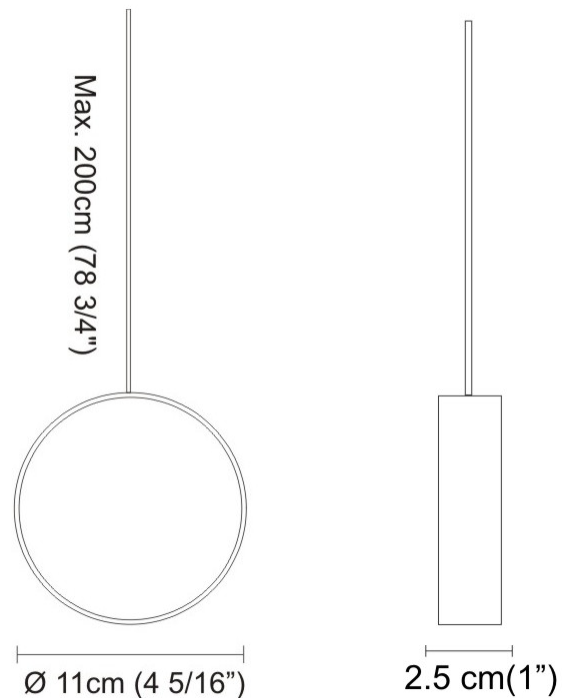
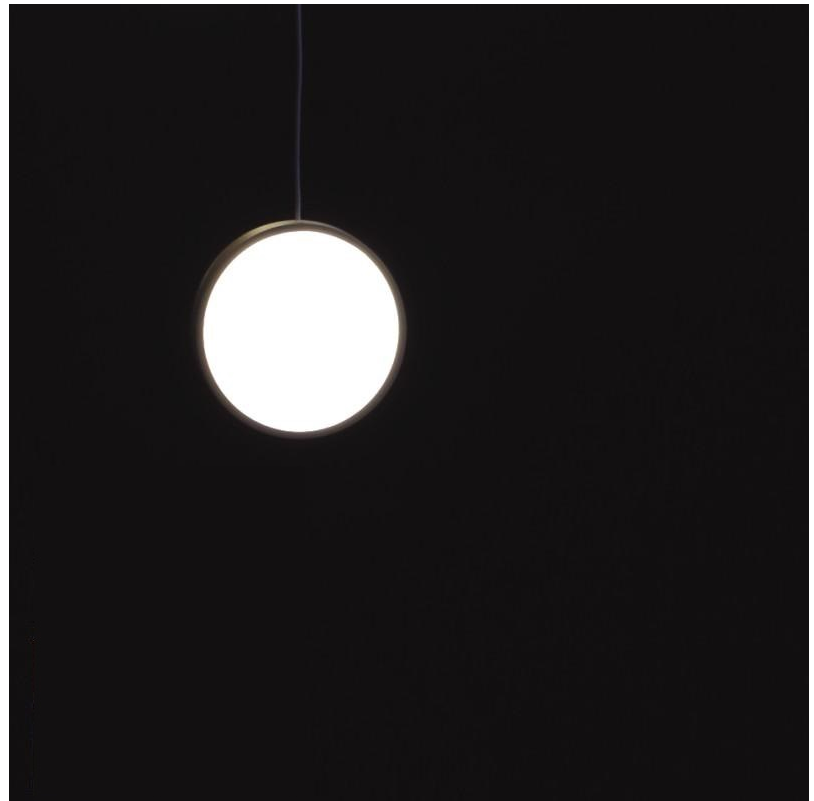

DO NOT DISTURB SUSPENSION

D131057-

PROJECT

TYPE

SPECIFIER

QUANTITY

DATE

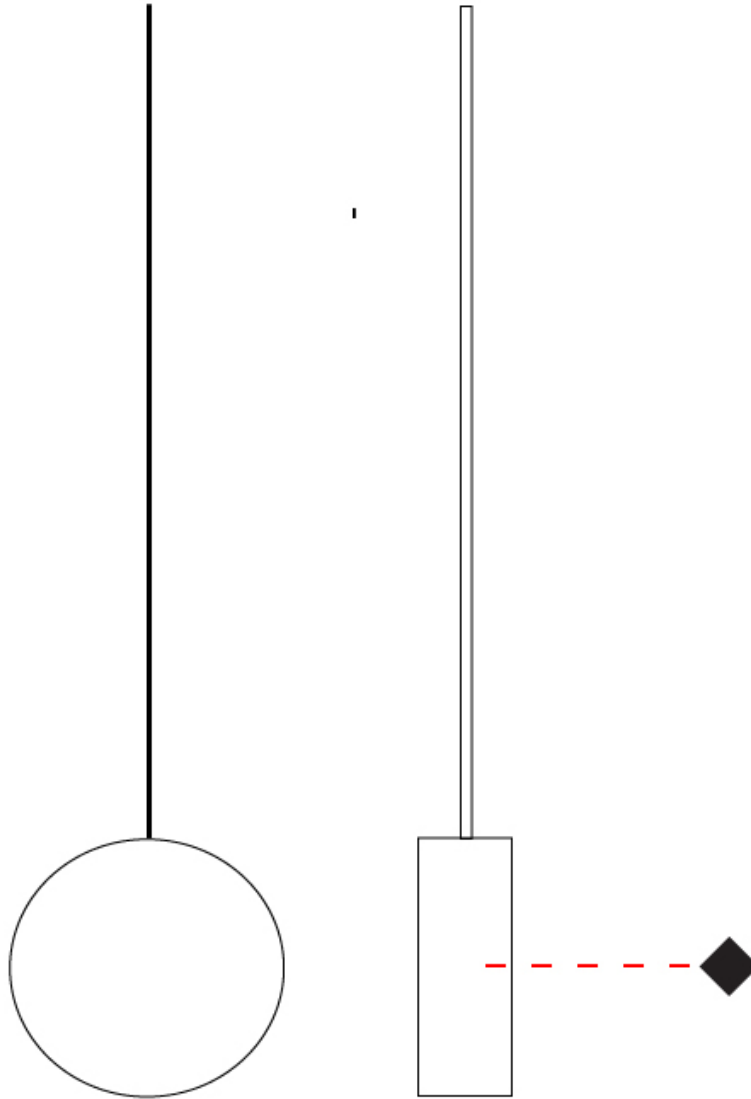

D

DO NOT DISTURB SUSPENSION

D131113-

base number _____
 Finish _____
 Options _____

- To build a product code in our configurator select the specify button on the base model # product page
- To build a manual product code on this datasheet choose from the options listed below in blue font and add the suffix to the base model #

GENERAL

Series: Do Not Disturb
 Partner: Knikerboker
 Division: Design
 Installation: Suspension
 Product Type: Pendant
 Mounting Location: Ceiling
 Light Distribution: Direct / Indirect

PHYSICAL

Shape: Round
 Length (mm): 300
 Length (in): 11 ¹³/₁₆
 Width (mm): 45
 Width (in): 1 ³/₄
 Diffuser: Opal
 Fixture Finish: [EWH](#) / [EBK](#) / [MAN](#) / [COF](#) / [PRD](#) / [SLF](#) / [GLF](#) / [CLF](#) / [BRL](#)
 Fixture Material: Metal
 Cable Details: Silicon Coaxial Cable 1500mm / 59 1/16"

ELECTRICAL

Lamp Type: LED
 Input Wattage (W): 16
 Total Output Wattage (W): 14
 Dimming: 0-10V Dimming / Phase Dimming (120Vac Only)
 Driver Included: Yes
 Driver Type: Constant Voltage - 120 / 277Vac
 Driver Class: Class 2
 Input Voltage (V): 120 - 277
 Output Voltage (V): 24
 Upon Request: 0-10Vdc dimming / Phase dimming @120Vac only / 277Vac

LED

Number of LEDs: 2
 Color Temperature (°K): 3000
 Max. Delivered Lumen (lm): 2000
 CRI: >85 CRI
 Lamp Life (hrs): 50000

OPTICAL

RATINGS AND CERTIFICATIONS

Certified By: Certified for North American Standards
 IP rating: IP20

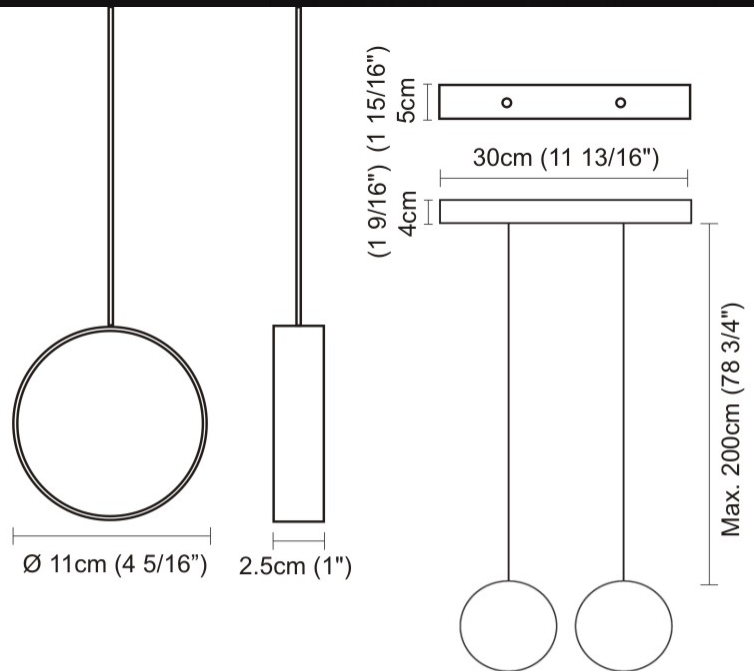

DO NOT DISTURB SUSPENSION

D131113-

PROJECT _____

TYPE _____

SPECIFIER _____

QUANTITY _____

DATE _____

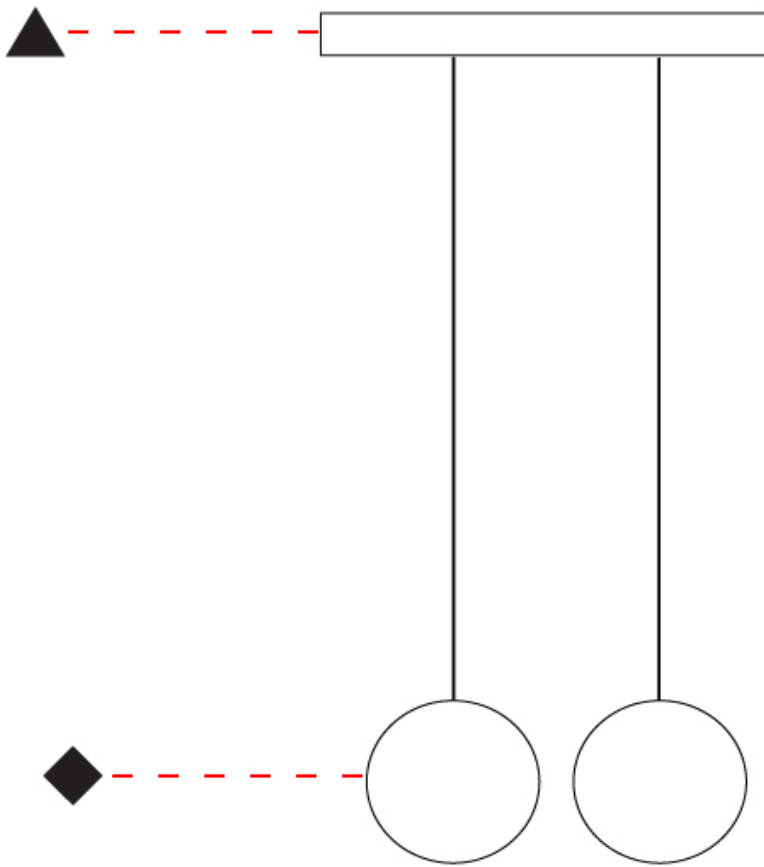

D

PROJECT	
TYPE	
SPECIFIER	
QUANTITY	
DATE	

DO NOT DISTURB SUSPENSION

D131117-

base number Finish
Options

- To build a product code in our configurator select the specify button on the base model # product page
- To build a manual product code on this datasheet choose from the options listed below in blue font and add the suffix to the base model #

GENERAL

Series: Do Not Disturb
 Partner: Knikerboker
 Division: Design
 Installation: Suspension
 Product Type: Pendant
 Mounting Location: Ceiling
 Light Distribution: Direct / Indirect

PHYSICAL

Shape: Round
 Length (mm): 550
 Length (in): 21 5/8
 Width (mm): 50
 Width (in): 2
 Diffuser: Opal
 Fixture Finish: [EWH / EBK / MAN / COF / PRD / SLF / GLF / CLF / BRL](#)
 Fixture Material: Aluminum
 Cable Details: Silicon Coaxial Cable 1500mm / 59 1/16"

ELECTRICAL

Lamp Type: LED
 Input Wattage (W): 32
 Total Output Wattage (W): 28
 Dimming: 0-10V Dimming / Phase Dimming (120Vac Only)
 Driver Included: Yes
 Driver Location: Integrated
 Driver Type: Constant Voltage - Universal
 Driver Class: Class 2
 Input Voltage (V): 120 - 277
 Output Voltage (V): 24
 Upon Request: (Not included - see components) Remote: Phase dimming @120Vac only / (Included) Integral: 0-10Vdc dimming / 277Vac

LED

Number of LEDs: 4
 Color Temperature (°K): 3000
 Max. Delivered Lumen (lm): 4000
 CRI: >85 CRI
 Lamp Life (hrs): 50000

OPTICAL

RATINGS AND CERTIFICATIONS

Certified By: Certified for North American Standards
 IP rating: IP20

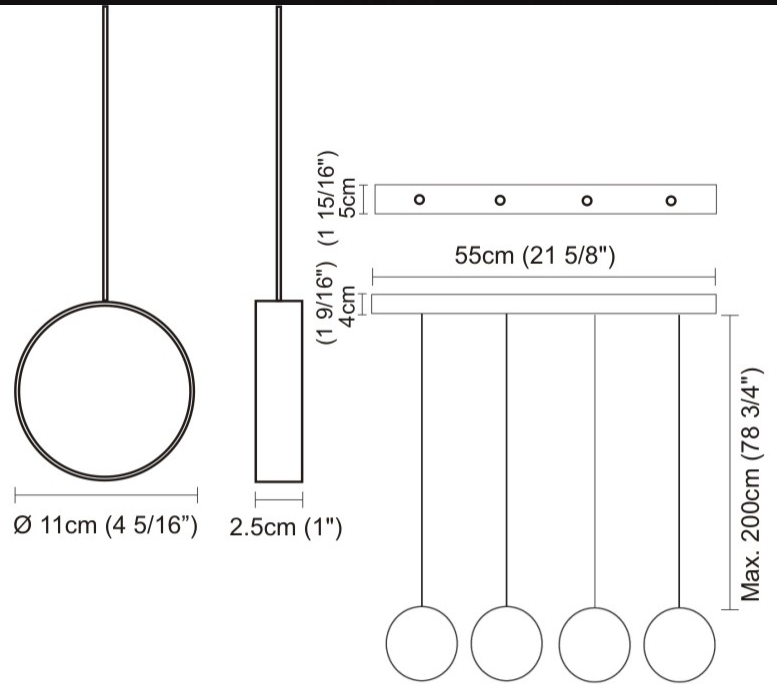

DO NOT DISTURB SUSPENSION

D131117-

PROJECT

TYPE

SPECIFIER

QUANTITY

DATE

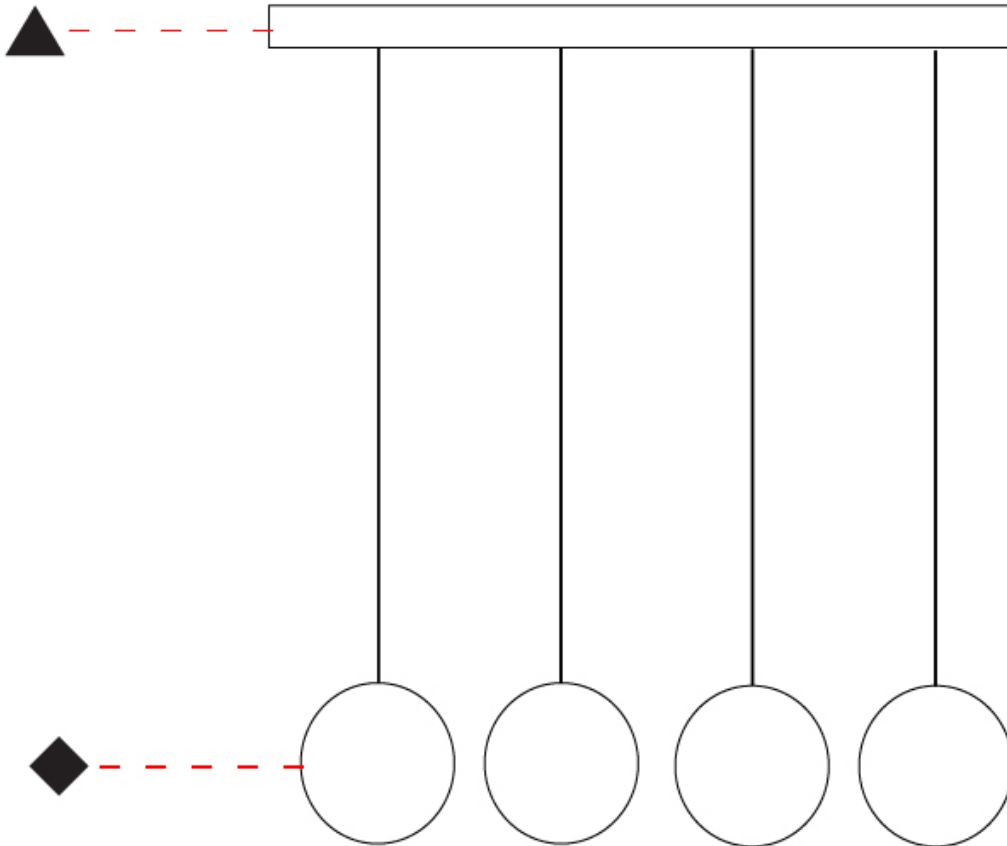

D

DO NOT DISTURB SUSPENSION

D131121-

base number _____
 Finish _____
 Options _____

1. To build a product code in our configurator select the specify button on the base model # product page
2. To build a manual product code on this datasheet choose from the options listed below in blue font and add the suffix to the base model #

GENERAL

Series: Do Not Disturb
 Partner: Knikerboker
 Division: Design
 Installation: Suspension
 Product Type: Pendant
 Mounting Location: Ceiling
 Light Distribution: Direct / Indirect

PHYSICAL

Shape: Round
 Diameter (mm): 245
 Diameter (in): 9 5/8
 Height (mm): 1500
 Height (in): 59 1/16
 Diffuser: Opal
[Fixture Finish: EWH / EBK / MAN / COF / PRD / SLF / GLF / CLF / BRL](#)
 Fixture Material: Aluminum
 Cable Details: Silicon Coaxial Cable 1500mm / 59 1/16"

ELECTRICAL

Lamp Type: LED
 Input Wattage (W): 40
 Total Output Wattage (W): 35
 Dimming: Non-Dimmable
 Driver Included: Yes
 Driver Location: Integrated
 Driver Type: Constant Voltage - Universal
 Driver Class: Class 2
 Input Voltage (V): 120 - 277
 Output Voltage (V): 24
 Upon Request: Remote: Phase dimming @120Vac only / Integral: 0-10Vdc dimming

LED

Number of LEDs: 5
 Color Temperature (°K): 3000
 Max. Delivered Lumen (lm): 5000
 CRI: >85 CRI
 Lamp Life (hrs): 50000

OPTICAL

RATINGS AND CERTIFICATIONS

Certified By: Certified for North American Standards
 IP rating: IP20

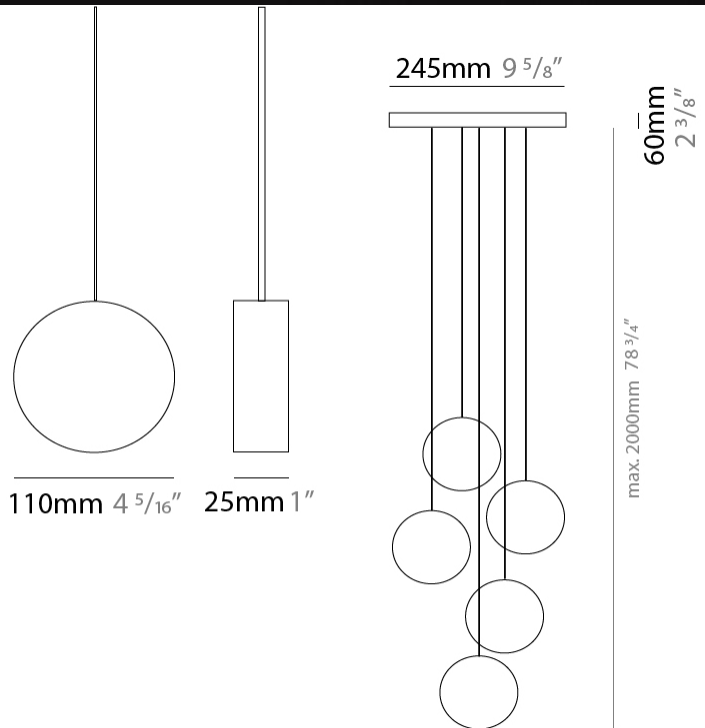

DO NOT DISTURB SUSPENSION

D131121-

PROJECT

TYPE

SPECIFIER

QUANTITY

DATE

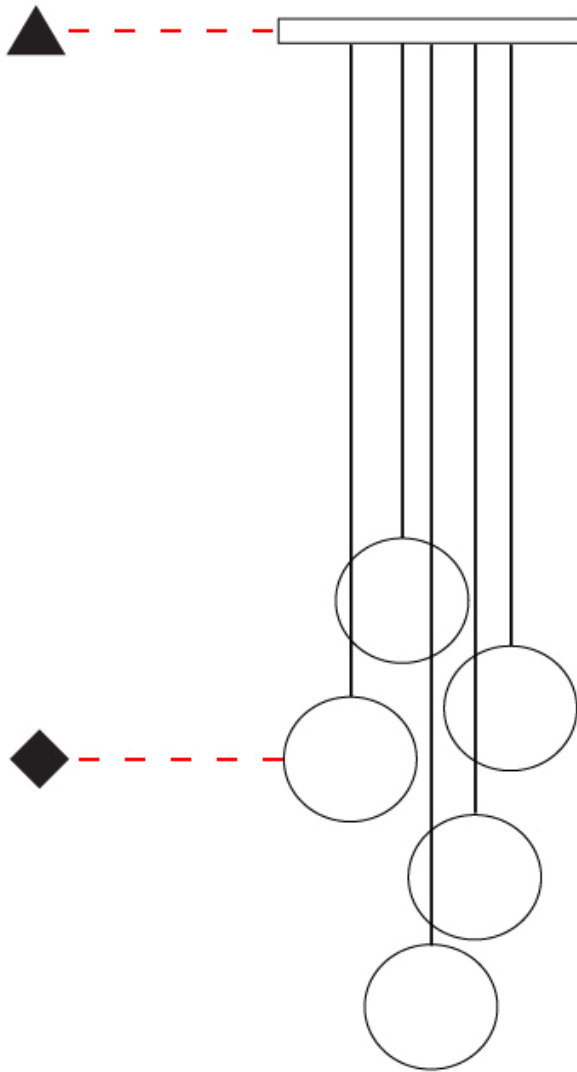

D

DO NOT DISTURB SUSPENSION

D131125-

base number _____
 Finish _____
 Options _____

- To build a product code in our configurator select the specify button on the base model # product page
- To build a manual product code on this datasheet choose from the options listed below in blue font and add the suffix to the base model #

GENERAL

Series: Do Not Disturb
 Partner: Knikerboker
 Division: Design
 Installation: Suspension
 Product Type: Pendant
 Mounting Location: Ceiling
 Light Distribution: Direct / Indirect

PHYSICAL

Shape: Round
 Diameter (mm): 900
 Diameter (in): 35 7/16
 Max. Overall Height (mm): 2000
 Max. Overall Height (in): 78 3/4
 Diffuser: Opal
 Fixture Finish: [EWH](#) / [EBK](#) / [MAN](#) / [COF](#) / [PRD](#) / [SLF](#) / [GLF](#) / [CLF](#) / [BRL](#)
 Fixture Material: Aluminum
 Cable Details: Silicon Coaxial Cable 10 Cables Of 1500mm / 59 1/16" 10 Cables Of 2000mm / 78 3/4"

ELECTRICAL

Lamp Type: LED
 Input Wattage (W): 160
 Total Output Wattage (W): 140
 Dimming: 0-10V Dimming / Phase Dimming (120Vac Only)
 Driver Included: Yes
 Driver Location: Integrated
 Driver Type: Constant Voltage - Universal
 Driver Class: Class 2
 Input Voltage (V): 120 - 277
 Output Voltage (V): 24
 Upon Request: (Not included - see components) Remote: Phase dimming @120Vac only / (Included) Integral: 0-10Vdc dimming / 277Vac

LED

Number of LEDs: 20
 Color Temperature (°K): 3000
 Max. Delivered Lumen (lm): 2000
 CRI: >85 CRI
 Lamp Life (hrs): 50000

OPTICAL

RATINGS AND CERTIFICATIONS

Certified By: Certified for North American Standards
 IP rating: IP20

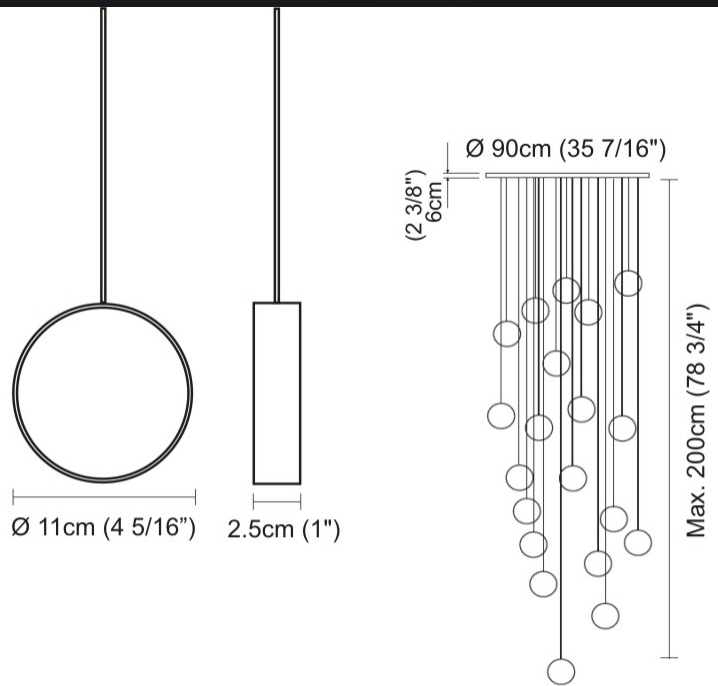

DO NOT DISTURB SUSPENSION

D131125-

PROJECT

TYPE

SPECIFIER

QUANTITY

DATE

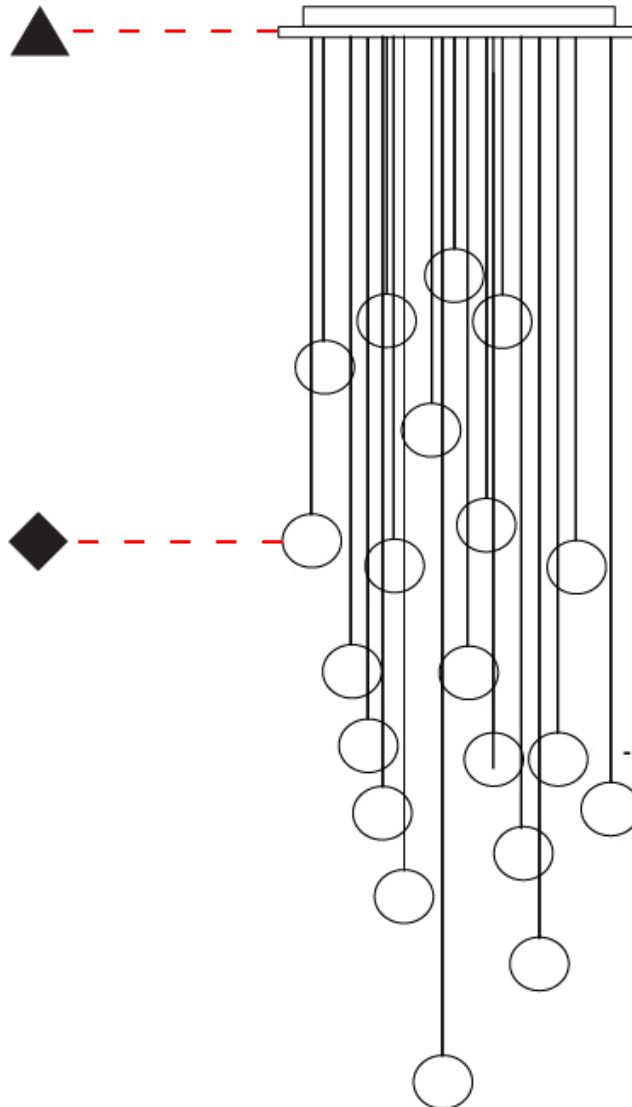

D

DO NOT DISTURB SUSPENSION

D131561-

base number _____
 Finish _____
 Options _____

- To build a product code in our configurator select the specify button on the base model # product page
- To build a manual product code on this datasheet choose from the options listed below in blue font and add the suffix to the base model #

GENERAL

Series: Do Not Disturb
 Partner: Knikerboker
 Division: Design
 Installation: Suspension
 Product Type: Pendant
 Mounting Location: Ceiling
 Light Distribution: Direct / Indirect

PHYSICAL

Shape: Round
 Diameter (mm): 500
 Diameter (in): 19 13/16
 Extension (mm): 1500
 Extension (in): 59 1/16
 Diffuser: Opal
 Fixture Finish: [EWH](#) / [EBK](#) / [MAN](#) / [COF](#) / [PRD](#) / [SLF](#) / [GLF](#) / [CLF](#) / [BRL](#)
 Fixture Material: Aluminum
 Cable Details: Silicion Coaxial Cable 1500 / 59 1/16

ELECTRICAL

Lamp Type: LED
 Input Wattage (W): 80
 Total Output Wattage (W): 70
 Dimming: Non-Dimmable / 0-10V Dimming
 Driver Included: Yes
 Driver Location: Integrated
 Driver Type: Constant Voltage - Universal
 Driver Class: Class 2
 Input Voltage (V): 120 - 277
 Output Voltage (V): 24
 Upon Request: Remote: Phase dimming @120Vac only

LED

Number of LEDs: 10
 Color Temperature (°K): 3000
 Max. Delivered Lumen (lm): 10000
 CRI: >85 CRI
 Lamp Life (hrs): 50000

OPTICAL

RATINGS AND CERTIFICATIONS

Certified By: CSA Certified to UL and CSA Standards
 IP rating: IP20

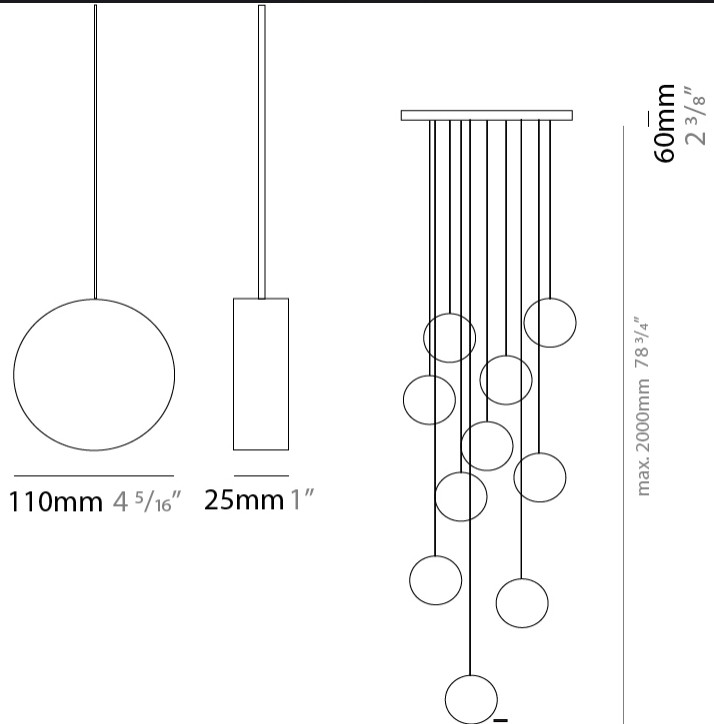
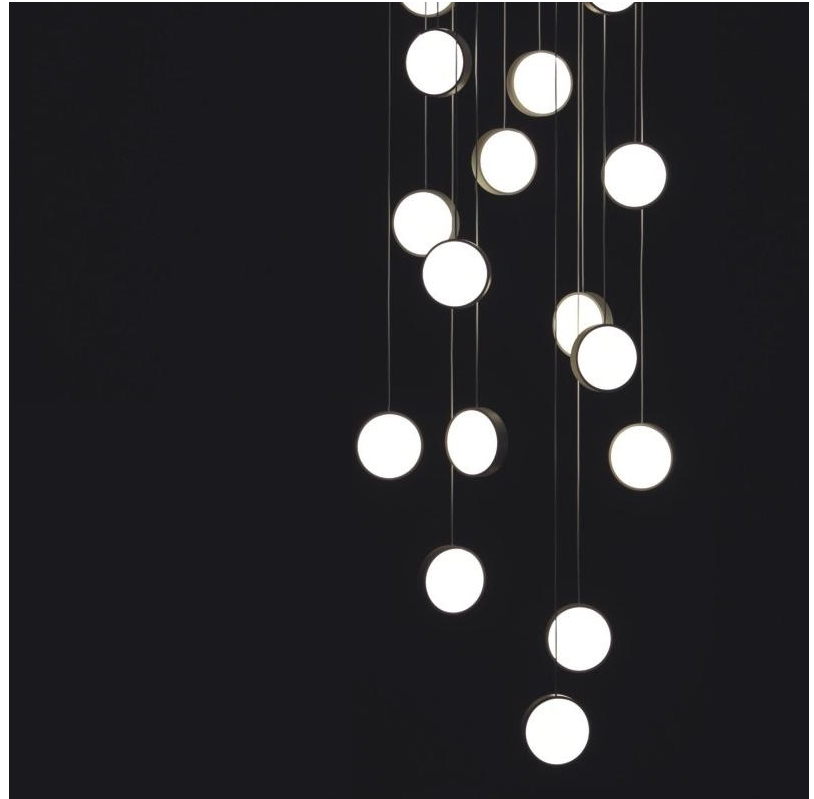

DO NOT DISTURB SUSPENSION

D131561-

PROJECT

TYPE

SPECIFIER

QUANTITY

DATE

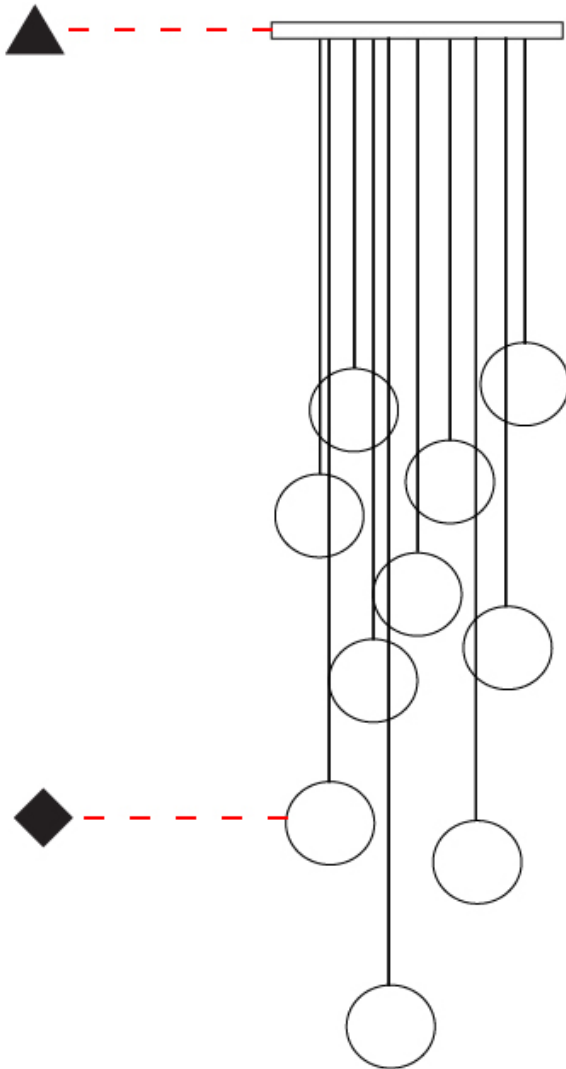

D

PROJECT	
TYPE	
SPECIFIER	
QUANTITY	
DATE	

DO NOT DISTURB SURFACE

D133027-

base number Finish
Options

- To build a product code in our configurator select the specify button on the base model # product page
- To build a manual product code on this datasheet choose from the options listed below in blue font and add the suffix to the base model #

GENERAL

Series: Do Not Disturb
 Partner: Knikerboker
 Division: Design
 Installation: Surface
 Product Type: Wall Surface
 Mounting Location: Wall
 Light Distribution: Direct / Indirect

PHYSICAL

Shape: Round
 Diameter (mm): 110
 Diameter (in): 4 3/16
 Length (mm): 30
 Length (in): 1 3/16
 Width (mm): 25
 Width (in): 1
 Height (mm): 162
 Height (in): 6 3/8
 Extension (mm): 255
 Extension (in): 10 1/16
 Diffuser: Opal
 Fixture Finish: [EWH](#) / [EBK](#) / [MAN](#) / [COF](#) / [PRD](#) / [SLF](#) / [GLF](#) / [CLF](#) / [BRL](#)
 Fixture Material: Metal

ELECTRICAL

Lamp Type: LED
 Total Output Wattage (W): 8
 Dimming: Non-Dimmable
 Driver Included: Yes
 Driver Location: Integrated
 Driver Type: Constant Voltage - Universal
 Driver Class: Class 2
 Input Voltage (V): 120 - 277
 Upon Request: Integral: Phase dimming 120Vac / (See components)
 Remote: 0-10Vdc dimming

LED

Number of LEDs: 1
 Color Temperature (°K): 3000
 Max. Delivered Lumen (lm): 1000
 CRI: >85 CRI
 Lamp Life (hrs): 50000

OPTICAL

RATINGS AND CERTIFICATIONS

Certified By: Certified for North American Standards
 IP rating: IP20

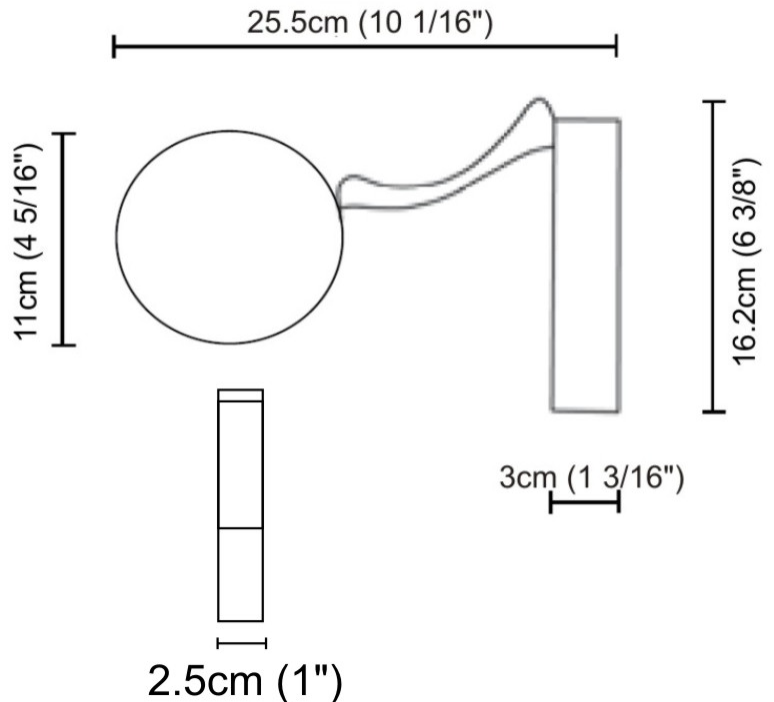

DO NOT DISTURB SURFACE

D133027-

PROJECT

TYPE

SPECIFIER

QUANTITY

DATE

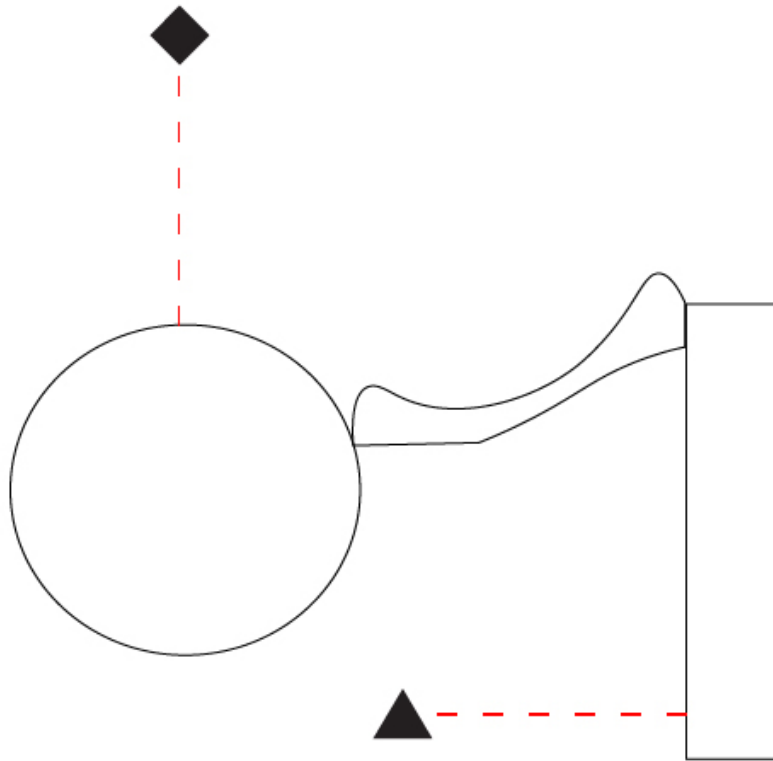

D

PROJECT	_____
TYPE	_____
SPECIFIER	_____
QUANTITY	_____
DATE	_____

DO NOT DISTURB PORTABLE

D134019-

base number Finish
Options

- To build a product code in our configurator select the specify button on the base model # product page
- To build a manual product code on this datasheet choose from the options listed below in blue font and add the suffix to the base model #

GENERAL

Series: Do Not Disturb
 Partner: Knikerboker
 Division: Design
 Installation: Portable
 Product Type: Table
 Mounting Location: Table
 Light Distribution: Direct / Indirect

PHYSICAL

Shape: Round
 Length (mm): 110
 Length (in): 4 ⁵/₁₆
 Width (mm): 30
 Width (in): 1 ³/₁₆
 Height (mm): 140
 Height (in): 5 ¹/₂
 Diffuser: Opal
 Fixture Finish: EWH / EBK / MAN / COF / PRD / SLF / GLF / CLF / BRL
 Fixture Material: Metal

ELECTRICAL

Lamp Type: LED
 Total Output Wattage (W): 8
 Dimming: Non-Dimmable
 Driver Included: Yes
 Driver Location: Integrated
 Driver Type: Constant Voltage 120Vac
 Driver Class: Class 2
 Input Voltage (V): 120
 Output Voltage (V): 24

LED

Number of LEDs: 1
 Color Temperature (°K): 3000
 Max. Delivered Lumen (lm): 1000
 CRI: >85 CRI

OPTICAL

RATINGS AND CERTIFICATIONS

Certified By: Certified for North American Standards
 IP rating: IP20

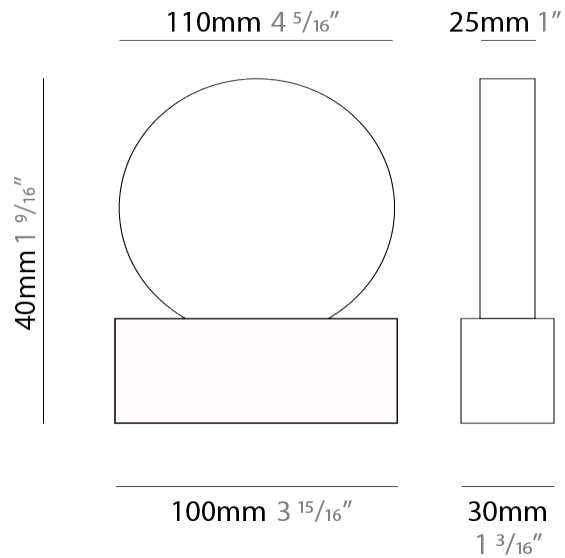

D134019-

PROJECT

TYPE

SPECIFIER

QUANTITY

DATE

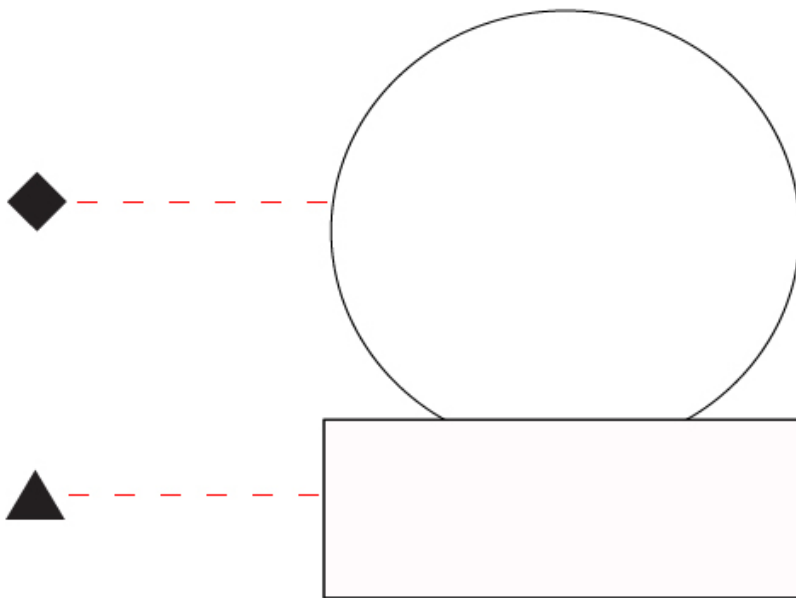

D

DO NOT DISTURB PORTABLE

D134023-

base number _____
 Finish _____
 Options _____

- To build a product code in our configurator select the specify button on the base model # product page
- To build a manual product code on this datasheet choose from the options listed below in blue font and add the suffix to the base model #

GENERAL

Series: Do Not Disturb
 Partner: Knikerboker
 Division: Design
 Installation: Portable
 Product Type: Table
 Mounting Location: Table
 Light Distribution: Direct / Indirect

PHYSICAL

Shape: Round
 Length (mm): 185
 Length (in): 7 ⁵/₁₆
 Width (mm): 30
 Width (in): 1 ³/₁₆
 Height (mm): 245
 Height (in): 9 ⁵/₁₆
 Diffuser: Opal
 Fixture Finish: EWH / EBK / MAN / COF / PRD / SLF / GLF / CLF / BRL
 Fixture Material: Metal

ELECTRICAL

Lamp Type: LED
 Input Wattage (W): 8
 Total Output Wattage (W): 7
 Dimming: Non-Dimmable
 Driver Included: Yes
 Driver Location: Integrated
 Driver Type: Constant Voltage - 120Vac
 Driver Class: Class 2
 Input Voltage (V): 120
 Output Voltage (V): 24

LED

Number of LEDs: 1
 Color Temperature (°K): 3000
 Max. Delivered Lumen (lm): 1000
 CRI: >85 CRI
 Lamp Life (hrs): 50000

OPTICAL

RATINGS AND CERTIFICATIONS

Certified By: Certified for North American Standards
 IP rating: IP20

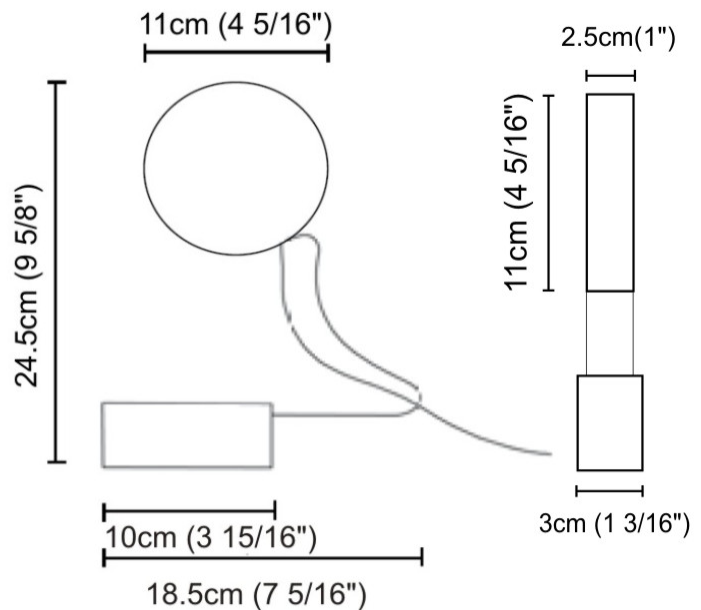

D134023-

PROJECT

TYPE

SPECIFIER

QUANTITY

DATE

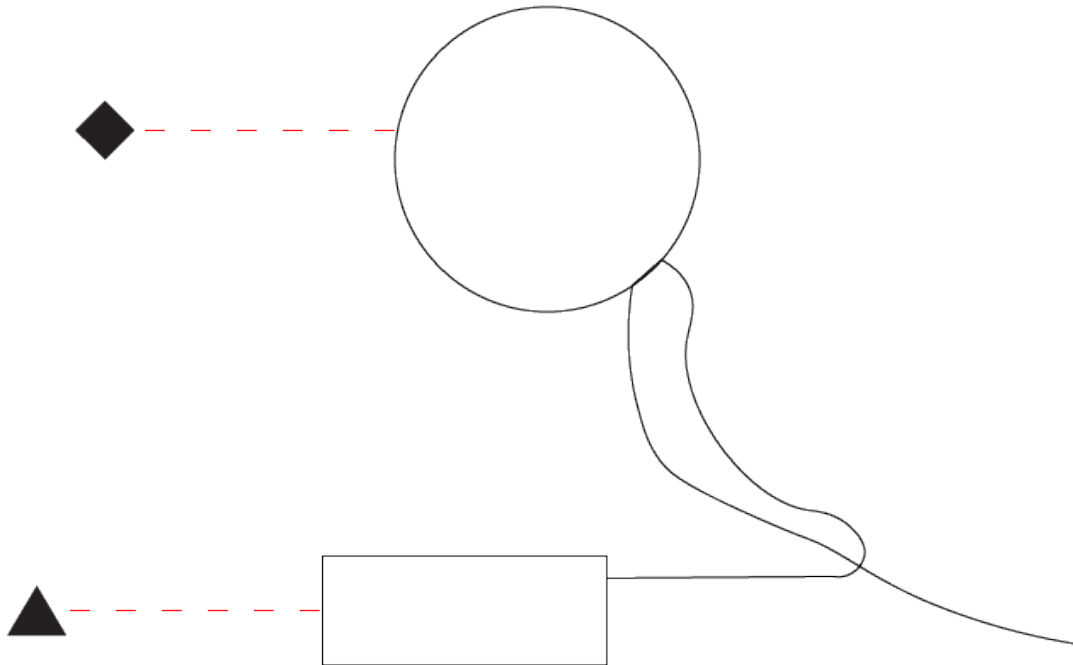

D

DO NOT DISTURB COLOR FINISH CHART

PROJECT _____

TYPE _____

SPECIFIER _____

QUANTITY _____

DATE _____

Fixture Finish

Embossed White - EWH



Embossed Black - EBK



Metallic Anthracite - MAN

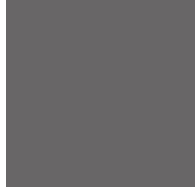

Coffee - COF

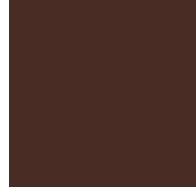

Purple Red - PRD



Silver Leaf - SLF

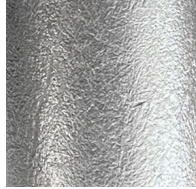

Gold Leaf - GLF



Copper Leaf - CLF



Bronze Leaf - BRL







































































Digital: Not all screens are calibrated the same, and therefore, colors will appear differently between screens.











Physical: When texture is involved, there will be variations in color, character and tone within a product series and between product families.













LEGEND

	floor-mounted		pivotal		special LED (upon request) RGB, RGBW, tunable, gold+, meat+, art+, fashion+
	wall and ceiling: recessed and surface mounted		rotating		warm dim / natural dimming LED
	ceiling-mounted and wall-mounted		illuminate tilted		rechargeable battery powered
	wall-mounted		color of suspension cable		fixture with natural vivid LED (upon request)
	omni-directional light distribution		length of suspension cable		color rendering index
	direct light distribution		reflector degree selection		color temperature
	direct/indirect light distribution		super spot		lumen (luminous flux)
	indirect light distribution		lens		efficacy (lumens per watt)
	asymmetric light distribution		lens pack		Unified Glare Rating (UGR) range from 5-40
	aura light distribution		shine ring		marine grade (AISI 316 stainless steel)
	round wall or ceiling cut-out		integrated shine ring with diffuser		walk on
	square wall or ceiling cut-out		free individual colors 01-29		drive on
	the supplied jig specifies the cutout dimensions		individual colors: 00 (free of charge), 01-25 (extra charge)		Dark Sky Compliance
	minimum distance (meters) lamp - object		luminaire part to be colored (F1)		Americans with Disabilities Act (less than 4" off the wall located between 27"-84" from floor)
	recessed depth		luminaire part to be colored (F2)		lamp protected against explosion
	ceiling thickness in mm		luminaire part to be colored (F3)		blown glass using traditional methods by master glass blower
	ceiling thickness selection		luminaire part to be colored (F4)		acoustic material
	dimmable DP (phase), DV (0-10V), DD (dali), DS (step-dim)		luminaire part to be colored (F5)		protection class I, protection insulation
	included or excluded LED driver/transformer/control gear		color of 3-circuit adaptor		protection class II, protection insulation
	separately switchable		indirect diffuser		ETL Certified to UL and CSA Standards
	sensor		direct diffuser		UL Certified to UL and CSA Standards
	remote control		ball-proof (upon request)		CSA Certified to UL and CSA Standards
	available upon request		accessory		Certified for North American Standards

IP RATING

	protected against ingress of solid bodies greater than 12.5mm (finger)
	protected against ingress of solid bodies greater than 2.5mm protected against sprays of water up to 60 degrees from the vertical (rain)
	protected against ingress of solid bodies greater than 1mm (wire) no protection against the ingress of moisture
	protected against ingress of solid bodies greater than 1mm (wire) protected against sprays of water up to 60 degrees from the vertical (rain)
	protected against ingress of solid bodies greater than 1mm (wire) protected against water splashed from all directions
	protected against limited ingress of dust (wet rooms/covered outdoor areas) protected against water splashed from all directions
	protected against ingress of dust protected against jets of water
	protected against ingress of dust protected against powerful jets of water or heavy seas
	protected against ingress of dust protected against immersion of water between 15cm - 1m for 30 minutes
	protected against ingress of dust protected against immersion of water under pressure for long periods

IK RATING

	protected against 0.14 joules impact (equivalent to 0.25kg mass dropped from 56mm above the surface)
	protected against 0.2 joules impact (equivalent to 0.25kg mass dropped from 80mm above the surface)
	protected against 0.35 joules impact (equivalent to 0.25kg mass dropped from 140mm above the surface)
	protected against 0.5 joules impact (equivalent to 0.25kg mass dropped from 200mm above the surface)
	protected against 0.7 joules impact (equivalent to 0.25kg mass dropped from 280mm above the surface)
	protected against 1 joules impact (equivalent to 0.25kg mass dropped from 400mm above the surface)
	protected against 2 joules impact (equivalent to 0.5kg mass dropped from 400mm above the surface)
	protected against 5 joules impact (equivalent to 1.7kg mass dropped from 300mm above the surface)
	protected against 10 joules impact (equivalent to 5.0kg mass dropped from 200mm above the surface)
	protected against 20 joules impact (equivalent to 5.0kg mass dropped from 400mm above the surface)